

Dealer

Key

standard

option

MIZAR

L Seat width	<input type="checkbox"/> 40 <input type="checkbox"/> 42 <input type="checkbox"/> 44 <input type="checkbox"/> 46 <input type="checkbox"/> 48
P Seat depth	<input type="checkbox"/> 38 <input checked="" type="checkbox"/> 40 <input type="checkbox"/> 42 <input type="checkbox"/> 44
HS Back-rest height	<input type="checkbox"/> 37 <input type="checkbox"/> 39 <input type="checkbox"/> 41 <input type="checkbox"/> 43
HA Front seat/floor height	50
HP Rear seat/floor height	47
DP Foot-rest/seat distance	<input type="checkbox"/> 37 <input type="checkbox"/> 39 <input type="checkbox"/> 41 <input type="checkbox"/> 43 <input type="checkbox"/> 45 <input type="checkbox"/> 47 <input type="checkbox"/> 49 cm

Quantity

Nr. pieces

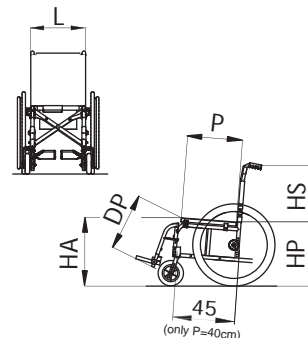

Frame colour

①

Metallic grey

Upholstery

②

-

- Without back-rest
 Without seat

Detachable foot-rests with plastic foot-plates and heel stops

③

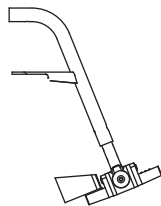

- Foot-holding belts

Elevating detachable foot-rests with plastic foot-plates and heel stops

④

(only P = 38 or 40 cm)

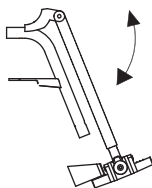

- Foot-holding belts

Anti-tip device

⑤

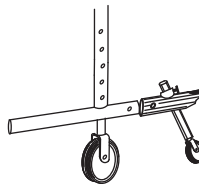

- Right
 Left

Features

- Aluminium folding frame;
- Steel single cross bar;
- Nylon fireproof upholstery;
- Tilt adjustable foot-plates;
- Heel stops;
- Height adjustable arm-rests;
- Unbalancing pedal;
- Weight w40xd40xh37 cm: 15,6 kg.

Detachable desk tip-up arm-rest - h 22 cm

⑥

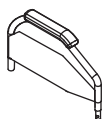

Elbow-rest

- Classic
 Hemiplegic RX
 Hemiplegic LX

Detachable "U" tip-up arm-rest h 22 cm

⑦

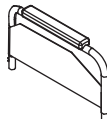

Elbow-rest

- Straight (26 cm long)
 Straight (36 cm long)
 Hemiplegic RX
 Hemiplegic LX

Detachable height adjustable tip-up arm-rest

⑧

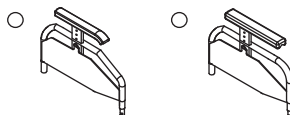

Elbow-rest

- Classic (23 cm long)
 Classic (30 cm long)
 Straight (26 cm long)
 Straight (36 cm long)
 Hemiplegic RX
 Hemiplegic LX

Rear wheels

⑨

- 24"
 12" solid
 12" pneumatic

- 24" Pneumatic plugged
 24" Solid

Handrims

⑩

- Aluminium silver
 Rubber coated
 Tween Grepp
 Max Grepp
 Max Grepp Ergo
 Silicon covers

Not available with 12" wheels

Table

⑪

- Transparent
 Rx Lx Hemiplegic Transp.
 Plastic grey
 Soft padded

Specify the fastening

- Single Double

(the double fastening is compulsory with height adjustable arm-rests)

Options

- 15 "M" velcro strip (hook) on seat
 16 "F" velcro strip (loop) on seat
 17 Seat/back-rest connection flap
 18 WC seat
 19 Padded rigid seat
 20 Chest harness
 21 Chest belt
 22 Abductor belt
 23 Catheter holder pocket
 24 Hinged back-rest
 25 Back anatomic board
 26 Rx Lx Crutch holder
 27 Pump for pneumatics
 28 45° pelvic belt
 29 45° padded pelvic belt
 30 Black holdall
 32 Umbrella holder
 33 Lined cushion, h 3cm high
 34 Lined cushion, h 5cm high

Front castors

⑫

- 175 (7"x1) solid
 175 (7"x1.3/4) solid
 175 (7"x1.3/4) pneumatic

Spoke guards

⑬

- Transparent
 Alphabet
 Fantasy
 code pattern:

(see catalogue of spokeguards)
Not available with 12" wheels

Small wheels for narrow passages

⑭

- Small wheels for narrow passages for 24" wheels

Note